

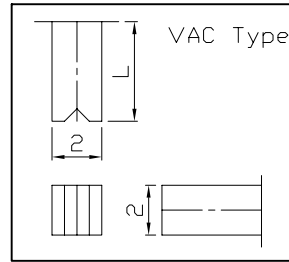

RoHS  
Compliant  
2002/95/EC

REV.	ECN.	NO.	APPD.

**DIMENSIONS**

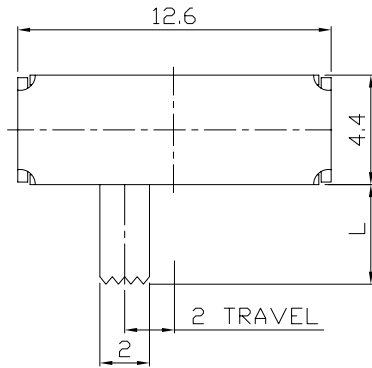

**MODEL CODE**

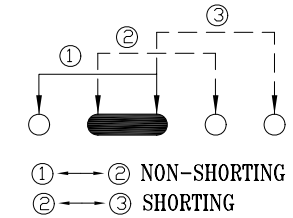
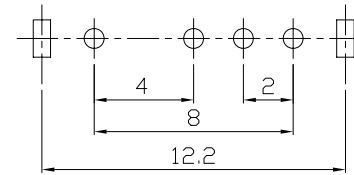
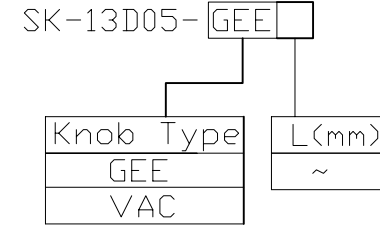

P.C.B LAYOUT  
BOTTOM VIEW

CIRCUIT DIAGRAM

**ELECTRO-MECHANICAL CHARACTERISTICS**

Refer to additional specifications

RATING	0.3A 30V DC
CIRCUIT	1P3T
CONTACT RESISTANCE	30mΩ MAX.
TIMING	NOT SPECIFIED
TRAVEL	2mm
OPERATING FORCE	<T1→T2 T3→T2>200±100gf <T2→T3 T2→T1>300±100gf
OPERATING LIFE(cycles)	10,000

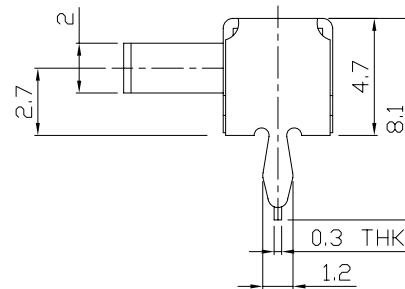
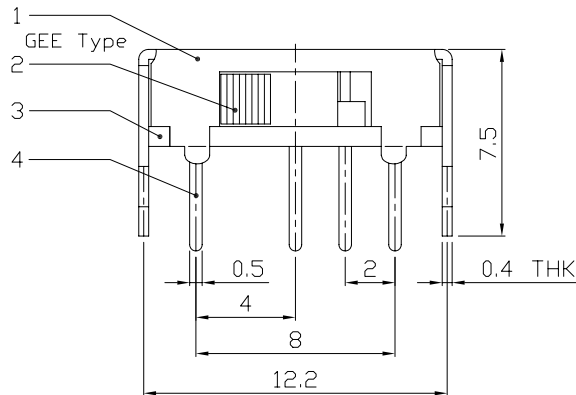

8					
7					
6	SPRING PLATE	STAINLESS STEEL	1	NATURAL	
5	CONTACT CLIP	PBS	1	Ag CLAD	
4	TERMINAL	BRASS STRIP	4	Ag PLATED OVER Ni PLATED	
3	BASE	PHENOLIC RESIN	1	NATURAL	
2	KNOB	POM	1	BLACK	
1	FRAME	STEEL STRIP	1	Ni PLATED	
NO.	PARTS	MATERIAL	Q'TY	FINISHING	

WITHIN 1.5mm: ±0.1mm  
OVER 1.5mm: ±0.2mm

UNITS mm

MAT'L SEE NOTE

FINISH SEE NOTE

Q'TY

THESE DRAWINGS AND SPECIFICATIONS ARE THE PROPERTY OF ACCURATE INNOVATECH INC AND SHALL NOT BE REPRODUCED, COPIED OR USED IN ANY MANNER WITHOUT THE PRIOR WRITTEN CONSENT OF ACCURATE INNOVATECH INC.

**龙创中业电子（深圳）有限公司**

TITLE: SLIDE SWITCH / HORIZONTAL PART NO.: SK-13D05

DR: Ricky 2015/12/08 DWG NO.: ADJ-13D05

CHKD: Ricky 2015/12/08

APPD:

SCALE	SHEET	REV.	CUSTOMER DRAWING
4:1	1/1	A	