

DIMENSIONS

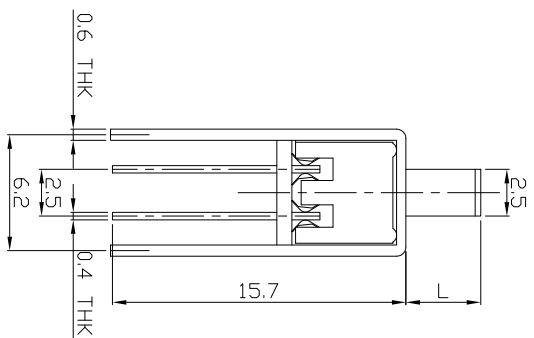

MODEL CODE
SS-23D24-GBF

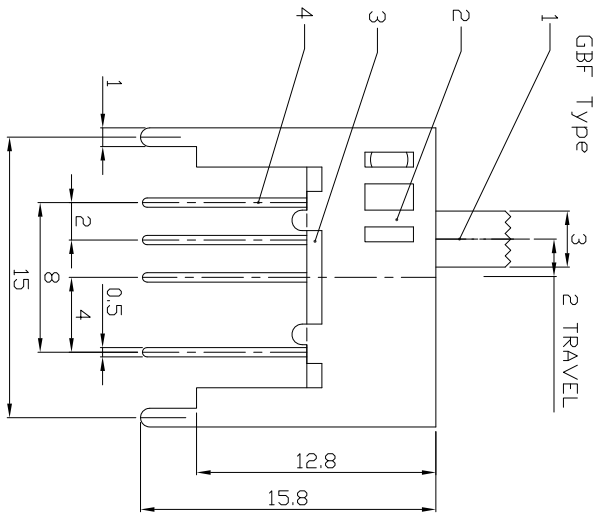
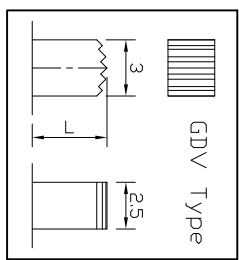
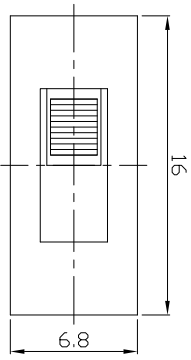
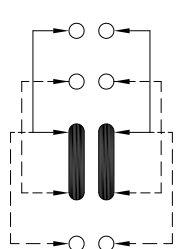
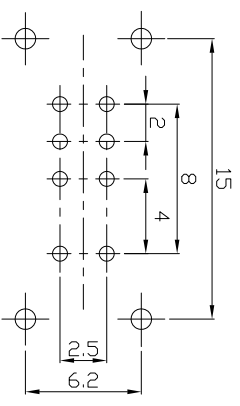
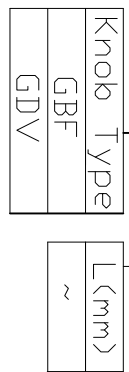

P.C.B LAYOUT
BOTTOM VIEW

CIRCUIT DIAGRAM

ELECTRO-MECHANICAL CHARACTERISTICS

Refer to additional specifications

| | |
|------------------------|-------------|
| RATING | 0.3A 50V DC |
| CIRCUIT | 2P3T |
| CONTACT RESISTANCE | 100mΩ MAX. |
| TIMING | SHORTING |
| TRAVEL | 2mm |
| OPERATING FORCE | 300±100gf |
| OPERATING LIFE(cycles) | 10,000 |

| | | | | | |
|---|--------------|----------------|------|-----------|----------------------|
| 8 | STEEL BALL | STEEL | 1 | NATURAL | WITHIN 1.5mm: ±0.1mm |
| 7 | SPRING | STEEL WIRE | 1 | NATURAL | OVER 1.5mm: ±0.2mm |
| 6 | CONTACT CLIP | PBS STRIP | 2 | Ag PLATED | |
| 5 | TERMINAL | BRASS STRIP | 8 | Ag PLATED | |
| 4 | BASE | PHENOLIC RESIN | 1 | NATURAL | |
| 3 | FRAME | STEEL STRIP | 1 | Ni PLATED | |
| 2 | KNDB | POM | 1 | BLACK | |
| 1 | PARTS | MATERIAL | Q'TY | FINISHING | |

UNITS mm
MATERIAL SEE NOTE
FINISH SEE NOTE

龙创中业电子(深圳)有限公司

TITLE: SLIDE SWITCH / VERTICAL

PART NO.: SS-23D24

DWG NO.: ADL-23D24

SCALE: 3:1

SHEET: 1/1

REV: A

APPD: [Signature]

CUSTOMER DRAWING